

UK PRICE LIST (£)

STUART TURNER

APRIL 2012 (2nd ISSUE)

(Supersedes October 2011 1st Issue)

Prices are Carriage Paid within
the United Kingdom excluding V.A.T.

 **monsoon**



 **monsoon
extra**

NEW



 **showermate**



 **showermate
eco**



 **wasteflo**

NEW



STUART

NEW



STUART



STUART



Stuart Turner Ltd reserve the right to amend prices or change product without notification.

Stuart Turner Ltd, Henley-on-Thames, Oxfordshire, RG9 2AD England

Tel +44 (0) 1491 572655, Fax +44 (0) 1491 573704

email: pumps@stuart-turner.co.uk, web: www.stuart-turner.co.uk

V.A.T. REG. No. 199 0987 92, Registered in England No. 88368, Registered Office: Market Place, Henley-on-Thames



Wasteflo products have a two year guarantee.

NEW

MACERATOR



NEW

LIFTING STATION



Model	Price	Part Number	Motor Watts	Max Flow Rate l/m	Inlet	Waste Outlet	Max. Vertical	Max Horizontal	Dimensions			Bar Code EAN-13
									W	H	D	
WC2	£419.38	46575	500	90	32 mm	32 mm	5 m	52 m	482	278	180	5050400465751
WC3	£489.96	46576	500	90	32 mm	32 mm	5 m	52 m	482	278	132	5050400465768
LS5	£435.35	46577	460	120	32 mm	32 mm	7 m	72 m	413	278	180	5050400465775



Monsoon pumps have a three year guarantee extendable to five years.

MONSOON UNIVERSAL



MONSOON STANDARD



Model	Price	Part Number	Specification						Performance		Connection Sizes	
			Motor		Impeller		Seal		Performance (bar) @ 9 litres per minute	Max. Head (bar) Valve Closed	Pump	Hoses
			230/1/50	Plastic	Brass	Nit/Cer	Nit/Sil	Vit/Sil				
NEGATIVE OR POSITIVE HEAD												
U1.5 bar Twin	£578.57	46505	●		●				1.2	1.5	G ¾ M	22 mm
U2.0 bar Twin	£599.27	46480	●		●				1.5	2.0	G ¾ M	22 mm
U3.0 bar Twin	£640.67	46410	●		●				2.5	3.0	G ¾ M	22 mm
U4.0 bar Twin	£682.07	46411	●		●				3.5	4.0	G ¾ M	22 mm
U4.5 bar Twin	£723.47	46412	●		●				3.8	4.5	G ¾ M	22 mm
U2.0 bar Single	£412.97	46498	●		●				1.5	2.0	G ¾ M	22 mm
U3.0 bar Single	£423.32	46413	●		●				2.5	3.1	G ¾ M	22 mm
U4.5 bar Single	£433.67	46414	●		●				3.5	4.3	G ¾ M	22 mm
POSITIVE HEAD												
S1.5 bar Twin	£418.14	46506	●		●				1.2	1.5	G ¾ M	22 mm
S2.0 bar Twin	£438.84	46415	●		●				1.5	2.0	G ¾ M	22 mm
S3.0 bar Twin	£490.59	46416	●		●				2.5	3.0	G ¾ M	22 mm
S4.0 bar Twin	£531.99	46417	●		●				3.5	4.0	G ¾ M	22 mm
S4.5 bar Twin	£573.39	46418	●		●				3.9	4.5	G ¾ M	22 mm
S2.0 bar Single	£293.94	46497	●		●				1.5	2.0	G ¾ M	22 mm
S3.0 bar Single	£304.29	46419	●		●				2.5	3.0	G ¾ M	22 mm
S4.5 bar Single	£320.85	46420	●		●				3.5	4.5	G ¾ M	22 mm

Bar Code EAN-13	WRAS Approved Number
5050400465058	0903033
5050400464808	0903033
5050400464105	0903033
5050400464112	0903033
5050400464129	0903033
5050400464983	0903033
5050400464136	0903033
5050400464143	0903033
5050400465065	0903032
5050400464150	0903032
5050400464167	0903032
5050400464174	0903032
5050400464181	0903032
5050400464976	0903032
5050400464198	0903032
5050400464204	0903032





Monsoon Extra pumps have a two year guarantee.

MONSOON EXTRA UNIVERSAL



NEW

MONSOON EXTRA STANDARD



MONSOON EXTRA PRESSURE SET

NEW



Model	Price	Part Number	Specification								Performance		Connection Sizes		Bar Code EAN-13	WRAS Approved Number		
			Motor	Impeller		Seal				Performance (bar) @ 9 litres per minute	Max. Head (bar) Valve Closed	Pump	Hoses					
			230/1/50	Plastic	Stainless Steel	Nit/Cer	Nit/Sil	Vit/Sil	Sil/Cer					Rating (kw)				
NEGATIVE HEAD																		
U1.4 bar Single	£489.00	46349	●	●			●				0.30	1.3	1.4	22 mm	22 mm	5050400463498	0512134	
U2.6 bar Single	£499.00	46593	●		●					●	0.55	2.4	2.6	G 1	G 1	5050400465935	WRAS Compliant	
U3.6 bar Single	£549.00	46594	●		●					●	0.75	3.6	3.7	G 1	G 1	5050400465942		
U5.0 bar Single*	£699.00	46595	●		●					●	1.10	5.0	5.1	G 1	G 1	5050400465959		
MONSOON EXTRA STANDARD																		
S1.4 bar Single	£382.95	46387	●	●			●				0.30	1.3	1.4	22 mm	22 mm	5050400463870	0304065	
MONSOON EXTRA PRESSURE SET																		
2.6 bar PS	£799.00	46601	●		●					●	0.55	2.4	2.6	G 1	G 1	5050400466017	WRAS Compliant	
3.6 bar PS	£849.00	46602	●		●					●	0.75	3.6	3.7	G 1	G 1	5050400466024		

* Available End 2012

showermate

Showermate pumps have a one year guarantee extendable to two years.

SHOWERMATE UNIVERSAL



SHOWERMATE STANDARD



SHOWERMATE ECO



Model	Price	Part Number	Specification						Performance		Connection Sizes	
			Motor	Impeller		Seal			Performance (bar) @ 9 litres per minute	Max. Head (bar) Valve Closed	Pump	Hoses
			230/1/50	Plastic	Brass	Nit/Car/Cer	Nit/Car/Sil	Vit/Car/Sil				
NEGATIVE HEAD												
U1.8 bar Twin	£379.79	46532	●	●		●			1.5	1.8	G ¾ M	15 mm
U2.6 bar Twin	£422.23	46533	●	●		●			2.0	2.6	G ¾ M	15 mm
U2.6 bar Single	£284.31	46534	●	●		●			1.5	2.6	G ¾ M	15 mm
POSITIVE HEAD												
S1.8 bar Twin	£206.48	46407	●	●		●			1.5	1.8	G ¾ M	15 mm
S2.6 bar Twin	£249.95	46431	●	●		●			2.0	2.6	G ¾ M	15 mm
S2.6 bar Single	£179.32	46429	●	●		●			1.5	2.6	G ¾ M	15 mm
POSITIVE HEAD												
S1.5 bar Twin	£155.25	46502	●	●		●			1.2	1.5	G ¾ M	15 mm
S2.0 bar Twin	£207.00	46500	●	●		●			1.5	2.0	G ¾ M	15 mm
S2.0 bar Single	£144.90	46503	●	●		●			1.2	2.0	G ¾ M	15 mm

Bar Code EAN-13	WRAS Approved Number
5050400465324	WRAS Compliant
5050400465331	
5050400465348	
50504004664075	0609117
50504004664310	0609117
50504004664297	0609117
5050400465027	1003059
5050400465003	1003059
5050400465034	1003059





STUART

Commercial pumps are guaranteed for one year.

CHM CENTRIFUGAL

NEW



Model	Price	Part Number	Specification											Max. Head metres	Max. Flow U/min	Connection Sizes		
			Motor			Impeller			Seal							Inlet BSP	Outlet BSP	
			230/1/50	12V d.c.	24V d.c.	Plastic	Brass	Stainless Steel	Nit/Cer/Cer	Nit/Cer/Sil	Vit/Cer/Sil	Sil/Cer/Cer	Rating (kw)					
CHM160-30	£280.00	46613	●					●				●	0.55	26	140	1 1/4"	1"	
CHM160-40	£330.00	46614	●					●				●	0.75	36	150	1 1/4"	1"	
CHM160-50	£480.00	46615	●					●				●	1.10	51	160	1 1/4"	1"	
CHM160-60	£530.00	46616	●					●				●	1.50	62	160	1 1/4"	1"	
CHM AUTOMATIC FLOW																		
NEW																		
																		
CHM160-30 FL	£349.00	46603	●					●				●	0.55	26	127	1 1/4"	1"	
CHM160-40 FL	£399.00	46604	●					●				●	0.75	36	140	1 1/4"	1"	
CHM160-50 FL*	£549.00	46605	●					●				●	1.10	51	142	1 1/4"	1"	
CHM160-60 FL*	£599.00	46606	●					●				●	1.50	62	144	1 1/4"	1"	
CHM BOOSTAMATIC																		
NEW																		
																		
CHM160-30 B	£449.00	46607	●					●				●	0.55	26	123	1 1/4"	1"	
CHM160-40 B	£499.00	46608	●					●				●	0.75	37	140	1 1/4"	1"	
CHM160-50 B*	£649.00	46609	●					●				●	1.10	51	142	1 1/4"	1"	
CHM160-60 B*	£699.00	46610	●					●				●	1.50	62	144	1 1/4"	1"	

Bar Code EAN-13	WRAS Compliant
5050400466130	✓
5050400466147	✓
5050400466154	✓
5050400466161	✓
5050400466031	✓
5050400466048	✓
5050400466055	✓
5050400466061	✓
5050400466079	✓
5050400466086	✓
5050400466093	✓
5050400466109	✓

* Available Late 2012

STUART

Commercial pumps are guaranteed for one year.

12/50

CENTRIFUGAL



KENNET

CENTRIFUGAL



Model	Price	Part Number	Specification											Max. Head metres	Max. Flow l/min	Connection Sizes		Bar Code EAN-13	WRAS Compliant			
			Motor			Impeller			Seal							Inlet BSP	Outlet BSP					
			230/1/50	12V d.c.	24V d.c.	Plastic	Brass	Stainless Steel	Nit/Car/Cer	Nit/Car/Sil	Vit/Car/Sil	Sil/Car/Cer	Rating (kw)									
12/50	£231.84	46164	●			●						●				0.13	14	55	¾"	¾"	5050400461647	
12/50	£263.93	46166	●				●					●				0.13	14	55	¾"	¾"	5050400461661	
12/50	£298.08	46167	●				●						●			0.13	14	55	¾"	¾"	5050400461678	
12/50 c/w Vent	£233.91	46212			●	●						●				0.18	14	55	¾"	¾"	5050400462125	
12/50	£263.93	46168			●	●						●				0.18	14	55	¾"	¾"	5050400461685	
12/50	£298.08	46169			●	●							●			0.18	14	55	¾"	¾"	5050400461692	
K7-2	£214.74	46372	●			●						●				0.18	9	130	1"	1"	5050400463726	✓
K9-2	£225.87	46374	●			●						●				0.25	9	160	1"	1"	5050400463740	✓
K12-2	£249.23	46379	●			●						●				0.50	14	210	1"	1"	5050400463795	✓
K12-2	£312.65	46381	●				●					●				0.50	14	210	1"	1"	5050400463818	✓
K12-2	£339.36	46383	●				●						●			0.50	14	210	1"	1"	5050400463832	✓

STUART

Commercial pumps are guaranteed for one year.

LODDON

CENTRIFUGAL



SELF PRIME

CENTRIFUGAL



SUBMERSIBLE



Model	Price	Part Number	Specification								Max. Head metres	Max. Flow l/min	Connection Sizes		Bar Code EAN-13	WRAS Compliant
			Motor		Impeller		Seal			Inlet BSP			Outlet BSP			
			230/1/50	Plastic	Brass	Nit/Cer	Nit/Sil	Vit/Sil	Double Lip					Rating (kw)		
L5-4S	£399.51	46398	●	●		●				0.60	47	90	1 1/4"	1"	5050400463986	✓
L7-4S	£570.29	46399	●		●		●			0.80	50	115	1 1/4"	1"	5050400463993	✓
X201	£409.86	45776	●	●		●				0.70	18	220	1 1/4"	1 1/4"	5050400457763	
Supersub 150VA	£87.90	46538	●	●					●	0.18	6.5	150	N/A	1 1/2"	5050400465386	
Supersub 250VA	£99.03	46539	●	●					●	0.35	8.5	250	N/A	1 1/2"	5050400465393	
Supersub 230A	£121.28	46540	●	●					●	0.40	8.3	230	N/A	1 1/2"	5050400465409	
Supervort 140A	£110.16	46541	●	●					●	0.22	5.0	140	N/A	1 1/2"	5050400465416	
Supervort 240A	£121.28	46542	●	●					●	0.42	7.4	240	N/A	1 1/2"	5050400465423	
Diver 35	£171.00	46585	●	●		●				0.72	34	88	N/A	1"	5050400465850	
Diver 45	£199.00	46586	●	●		●				1.00	42	94	N/A	1"	5050400465867	
Diver 35 Boostamatic	£240.95	46611	●	●		●				0.72	34	88	N/A	1"	5050400466116	
Diver 45 Boostamatic	£268.95	46612	●	●		●				1.00	42	94	N/A	1"	5050400466123	

STUART

Commercial pumps are guaranteed for one year.

BRASS VERTICAL PERIPHERAL SUCTION



BRASS END PERIPHERAL SUCTION



STAINLESS STEEL PERIPHERAL SUCTION



Model	Price	Part Number	Specification						Max. Head metres	Max. Flow U/min	Connection Sizes		Bar Code EAN-13	WRAS Compliant		
			Motor	Impeller			Seal				Inlet BSP	Outlet BSP				
			230/1/50	Plastic	Brass	Stainless Steel	Nit/Car/Cer	Nit/Car/Sil							Vit/Car/Sil	Rating (kw)
RG4000 c/w vent plug	£178.23	46443	●	●			●			0.09	30	35	¾"	¾"	5050400464433	✓
RG4000 c/w vent plug	£196.71	46444	●	●				●		0.09	30	35	¾"	¾"	5050400464440	✓
RG4000 c/w vent plug	£214.10	46445	●	●					●	0.09	30	35	¾"	¾"	5050400464457	
RG6000 c/w vent plug	£199.96	46495	●	●			●			0.37	42	44	¾"	¾"	5050400464952	✓
RG6000 c/w vent plug	£217.35	46447	●	●				●		0.37	42	44	¾"	¾"	5050400464471	✓
RG6000 c/w vent plug	£235.83	46448	●	●					●	0.37	42	44	¾"	¾"	5050400464488	
ES4000	£180.40	46449	●	●			●			0.09	30	25	1"	1"	5050400464495	✓
ES4000	£198.88	46450	●	●				●		0.09	30	25	1"	1"	5050400464501	✓
ES4000	£216.27	46451	●	●					●	0.09	30	25	1"	1"	5050400464518	
ES6000	£202.14	46452	●	●			●			0.37	42	34	1"	1"	5050400464525	✓
ES6000	£219.52	46453	●	●				●		0.37	42	34	1"	1"	5050400464532	✓
ES6000	£238.00	46454	●	●					●	0.37	42	34	1"	1"	5050400464549	
RG550-2	£417.31	46455	●				●	●		0.37	40	38	¾"	¾"	5050400464556	✓
RG550-2	£444.49	46469	●				●		●	0.37	40	38	¾"	¾"	5050400464693	✓

STUART

Commercial pumps are guaranteed for one year.

FLOW SWITCH







AUTOMATIC



BOOSTAMATIC PRESSURE CONTROL

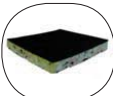

Model	Price	Part Number	Specification								Max. Head metres	Max. Flow l/min	Connection Sizes		Bar Code EAN-13	WRAS Compliant	
			Motor	Impeller			Seal			Rating (kw)			Inlet BSP	Outlet BSP			
			230/1/50	Plastic	Brass	Stainless Steel	Nit/Cer/Cer	Nit/Cer/Sil	Vit/Cer/Sil								
ESFL4000	£245.61	46521	●		●			●			0.18	24	29	1"	1"	5050400465218	✓
ESFL6000	£267.34	46520	●		●			●			0.37	42	34	1"	1"	5050400465201	✓
KFL9-2	£283.72	46384	●	●				●			0.18	8	130	1"	1"	5050400463849	✓
KFL12-2	£290.40	46385	●	●				●			0.25	13	170	1"	1"	5050400463856	✓
RGFL4000	£247.78	46522	●		●			●			0.18	24	33	¾"	¾"	5050400465225	✓
RGFL6000	£259.74	46530	●		●			●			0.37	42	35	¾"	¾"	5050400465300	✓
RGDFL6000	£391.23	46531	●		●			●			0.55	34	66	¾"	¾"	5050400465317	✓
LFL5-4S	£494.73	46400	●	●					●		0.60	47	90	1¼"	1"	5050400464006	✓
LFL7-4S	£663.44	46401	●	●					●		0.80	50	110	1¼"	1"	5050400464013	✓
Boostamatic 4000	£296.69	46523	●		●			●			0.18	24	29	1"	1"	5050400465232	✓
Boostamatic 6000	£309.73	46524	●		●			●			0.37	42	34	1"	1"	5050400465249	✓
Boostamatic K7-2	£405.00	46525	●	●				●			0.25	14	125	1"	1"	5050400465256	✓
Boostamatic L5-4S	£579.60	46528	●	●					●		0.60	47	90	1¼"	1"	5050400465287	✓
Boostamatic L7-4S	£752.45	46529	●	●					●		0.80	50	104	1¼"	1"	5050400465294	✓

ACCESSORIES		Description	Price (Each)	Part Number (Individual)	Bar Code EAN-13
ELECTRICAL ACCESSORIES					
		Control Module 1.5 bar cut in pressure c/w built in NRV	£79.95	41011	
FLOAT SWITCH					
		F1 20/8 MKIV Single Pole	£36.21	26638	5050400266389
FLOATING SWITCHES					
		Floating Switch - 3 m - Fill only	£29.95	19500	5050400195009
		Floating Switch - 5 m - Fill only	£34.50	19501	5050400195016
		Floating Switch - 3 m - Fill or empty	£32.95	19638	5050400196389
		Floating Switch - 5 m - Fill or empty	£37.95	19639	5050400196396
STUART FLANGE					
		Stuart Flange	£29.95	27800	5050400266389
STRAINER					
		3/4 " BSP Inline Strainer	£29.95	15726	
		1 " BSP Inline Strainer	£30.21	16291	
CONNECTING HOSES					
		Flexible Hose Kit 15 mm, G 3/4 Running Nut	£29.95	19294	
		Flexible Hose Kit G 3/4, 15 mm 'DM' Fit with isolating valve	£29.95	27764	
		Anti-Vibration Flexible Pipe Connection 22 mm push-in/22 mm O/D	£29.95	27680	
		Anti-Vibration Flexible Pipe Connection 3/4 " BSPF/22 mm push-in with isolating valve	£32.02	27783	
MOUNTING PADS					
		Anti-Vibration Pump Mounting Pad	£29.95	27124	

SERVICE KITS/SPARES

We support our products with an extensive range of spare parts and service kits.
For further help please visit our website on www.stuart-turner.co.uk
or contact 'Pump Assist' on 0844 98 000 97

The screenshot shows the Stuart Turner website homepage. At the top left is the 'STUART TURNER' logo. To the right, it says 'Inspired by water, delivered through technology'. Below this is a navigation menu with links: Home, Products, Sectors, Where to buy, Pump Assist, Downloads, News and Events, Contact Us, and About Us. A search bar is located in the top right corner. The main content area features a 'Residential' section with a sidebar listing categories like Residential, Non residential, Leisure, Marine, MoD, Transport, Recycling, Horticulture, Medical, Commercial, and Bespoke. The 'Residential' section includes a welcome message and a 'Pump Assist' service box. Below the main content are three promotional boxes: 'Register your FREE* guarantee extension >', 'Register online to receive news and product updates >', and 'News and Events' with links to various updates. At the bottom right of the screenshot is a 'Training Academy' button.

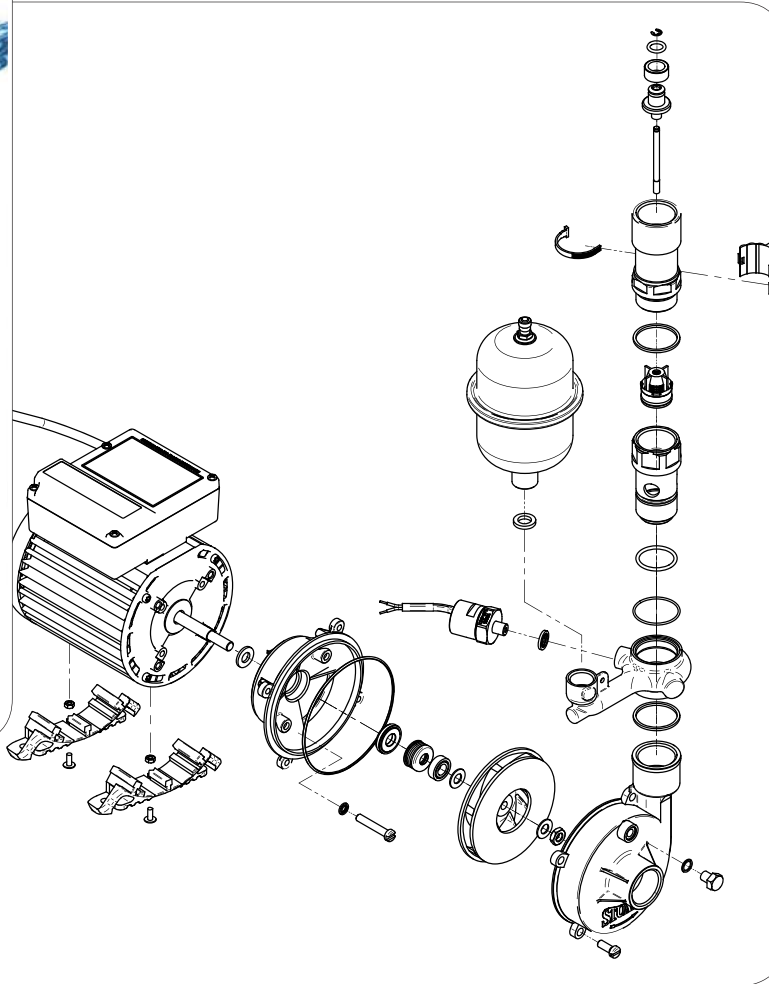

Stuart Turner Ltd, Henley-on-Thames, Oxfordshire, RG9 2AD England

Tel +44 (0) 1491 572655, Fax +44 (0) 1491 573704

email: pumps@stuart-turner.co.uk, web: www.stuart-turner.co.uk

V.A.T.REG. No. 199 0987 92, Registered in England No. 88368, Registered Office: Market Place, Henley-on-Thames